



Assembled cabanas are large & heavy. Put together at place of use.

CABANA / PAVILION ASSEMBLY ALUMINUM FRAME MODELS

Thank you for selecting Tropitone's Basta Sole Cabana / Pavilion for your shade needs.

WARNING: Do not try to lift or flip Cabanas / Pavilions with only one person. Components may be heavy and awkward to handle, and may result in injury to persons or damage to property if not lifted properly.

CAUTION: When instructed to fully tighten screws, do not over tighten and strip the threads.

- ✓ Read through all steps before starting assembly.
- ✓ Completely unpack all boxes and thoroughly check for items that may be individually wrapped (finial, etc.)
- ✓ Use the shipping carton, pool towels or a tarp to prepare a clean work surface.

Tools needed:

Medium Phillips Screwdriver	Level
Pliers (may assist on thumb screws)	Safety Glasses

Parts List:

(1) Finial (decorative top)	(1) Upper Frame Assembly with Top Cover
(4) Pan Head Screws	(4) Corner Bracket Assembly
(4) Center Brackets	(4) Curtain Rods (longer, thinner)
(8) Long Thumb Screws	(4) Curtains
(16) Short Thumb Screws	(4) Poles (shorter, thicker)
(4) Decorative Tassels *	(4) Umbrella Bases (see page 7 for various types)
(20 ~ 56) Curtain Rings *	

* (varies by model, see pg 5)

NOTICE: Cabanas / Pavilions require periodic care including tightening of hardware, cleaning and snap lubrication.

Step 1

Prepare a smooth, non-scratch surface work surface (shipping container, a tarp or pool towels can be used). Set the (4) Corner Bracket Assemblies in a square spaced the distance of the Curtain Rods.

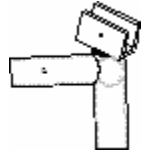

Connect the (4) Curtain Rods to the Corner Bracket Assemblies. Rods vary in diameter for various models:

- Narrow Curtain Rods slide inside the end tube on the Corner Bracket Assembly.
- Wide Curtain Rods slide over the end tube on the Corner Bracket Assembly. Ignore drilled holes on Corner Bracket end tube; it isn't used.

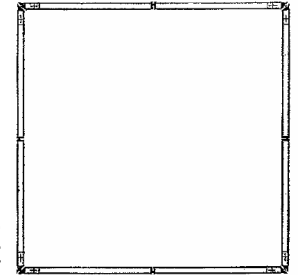

Slide Rods **fully** into or onto the end tube. Install (8) Short Thumb Screws loosely to retain the Curtain Rods (at 4 corners).

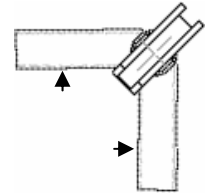

Do NOT fully tighten the Thumb Screws until Step 3.

Step 2

Install the (4) Curtain Rod Brackets onto the Curtain Rods using the (4) Pan Head Screws. Fully tighten the screws, but do not over tighten and strip the threads.

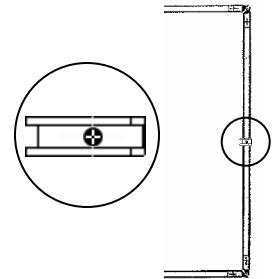

Rotate the Curtain Rod about 30° so the Bracket can receive the Arm in Step 3 as shown in the cutaway diagram.

Do NOT fully tighten the Thumb Screws retaining the Curtain Rods until Step 3.

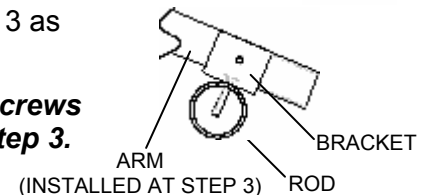

Step 3

Install the Finial (decorative top) onto the Upper Frame Assembly.



With two or more persons, carefully open the Upper Frame Assembly to be fully open.

Place the Upper Frame Assembly onto the Corner Brackets with the Arms in the Bracket channels (at 4 corners).

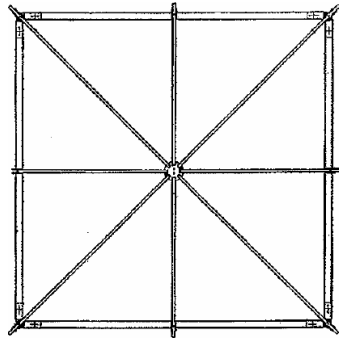

Position the center arms into the Curtain Rod Brackets (4 places). Rotate the Curtain Rod to fit the center arm into the Curtain Rod Bracket.

Install the Long Thumb Screws into the Curtain Rod Brackets (4 places). Fully tighten.

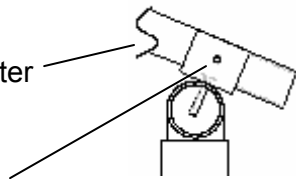

Install the Long Thumb Screws into the Corner Brackets (at 4 corners). Fully tighten.

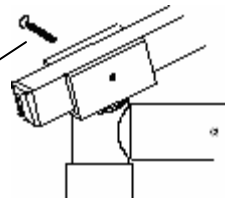

Fully tighten (8) Short Thumb Screws to secure the Curtain Rods to the Corner Bracket Assemblies (8 places).

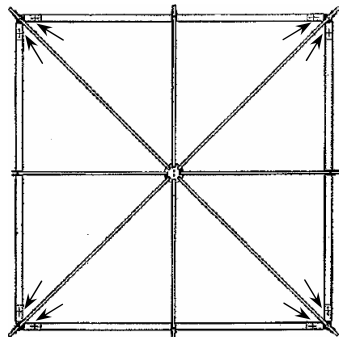

Step 4

Using two persons, lift one side of the Cabana high enough to insert two Corner Poles. Install Poles.

Install Short Thumb Screws to hold the Corner Poles to the Corner Bracket Assemblies. Fully tighten the Thumb Screws (2 places).

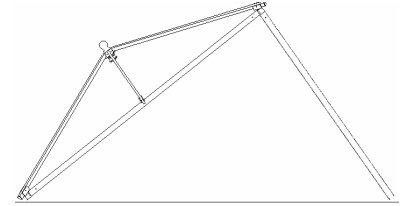

WARNING: Thumb Screws must be fully tightened to secure the Poles to the Corner Bracket Assemblies. Failure to do so may cause the Corner Poles to separate from the Corner Bracket Assemblies and result in injury to persons or damage to property.

Using two persons, lift the remaining side of the Cabana high enough to insert two Corner Poles. Install Poles.

Install Short Thumb Screws to hold the Corner Poles to the Corner Bracket Assemblies. Fully tighten the Thumb Screws (2 places).

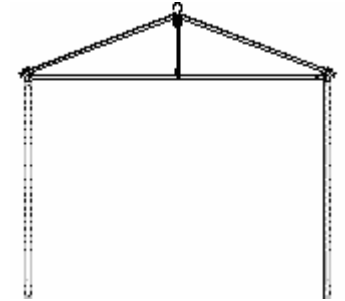

Step 5

Place an Umbrella Base at each pole (see page 7 for various types). Lift the Corner Poles onto the Base Sleeve. Push the Base into place and align each Pole into a vertical position.

Install (4) Short Thumb Screws to hold the Corner Poles to the Umbrella Base. Fully tighten the Thumb Screws (at 4 corners).

Confirm that Poles are straight up and down with a level.

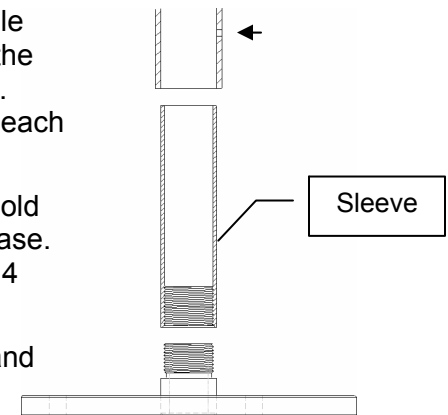

Step 6

Curtains are installed outside the Poles.

- Curtains with ties attached - ties face outside the cabana.
- Curtains with retaining loops - loops face inside with one loop on each side of the pole.

Open the Rings by gently twisting the clasp and pulling apart. Install the Curtain Rings onto the Curtains and the Curtain Rod: pass the Ring through the Curtain eyelet and then over the Curtain Rod. Close the Ring until the clasps engage. Some Cabana / Pavilion models have Rings with a plastic sleeve to lock the clasp; slide the sleeve over the clasp.

Fully open the Curtains and tie back.

Note: Specific Cabanas / Pavilions are equipped with decorative Corner Curtains that do not fully enclose the side of the Cabana. These also have decorative tassels.

Optional Center Panels are available to fully enclose the sides. The Center Panels should be installed at this time, if equipped.

Fully open the Curtains. Put one side of the Decorative Tassel in the retaining loop and snap closed. Extend the Tassel around the outside Curtain and snap the retaining loop closed.

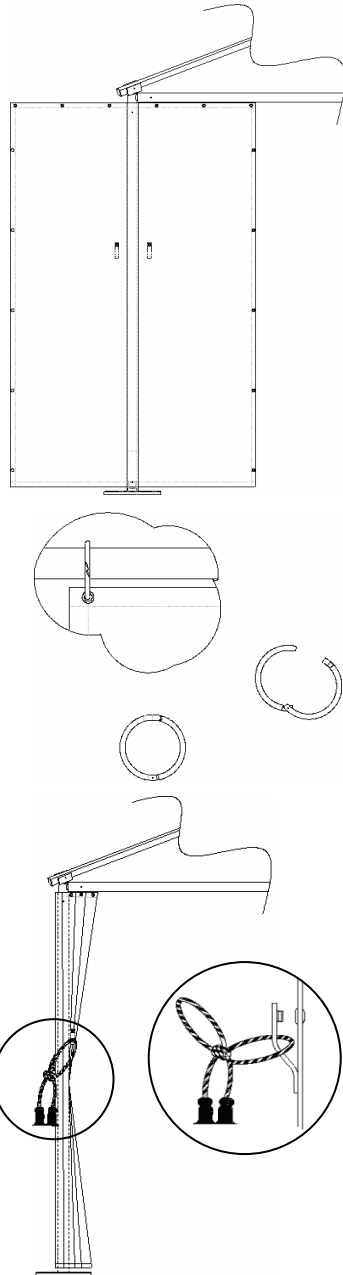

Step 7

Double-check that all the Thumb Screws are fully tightened, but do not over tighten and strip the threads.

Work carefully around the Cabana / Pavilion to insure you don't skip any Thumb Screws – indicators below show Thumb Screw locations for 2 of 4 sides (the other two sides are similar and need the same confirmation).

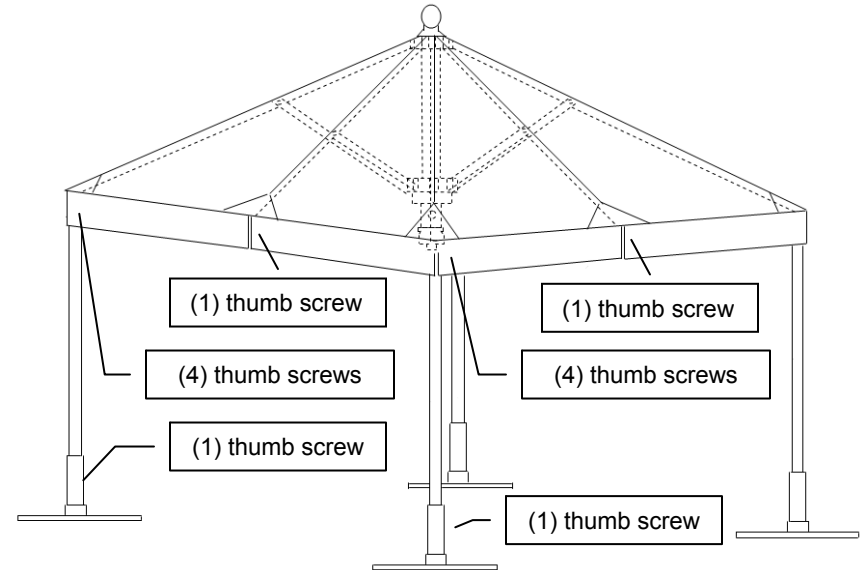

Periodic Maintenance

Periodic maintenance is needed to insure safety and proper operation over the life of the Cabana / Pavilion.

- ✓ Double-check that all the Thumb Screws are fully tightened, but do not over tighten and strip the threads.
- ✓ Apply a silicon lubricate to snaps with a swab to insure proper operation. *Do not spray lubricant or get lubricant on fabric.*
- ✓ Confirm all Curtain Rings are in place and closed.
- ✓ Repair any corrosion promptly to minimize damage to finish. (see Care and Maintenance guide)

Typical Cabana / Pavilion Bases

Below are typical Umbrella Bases used with Cabanas and Pavilions.

- 12" round Steel Plate Bases should be bolted to the ground using 3/8" bolts (not included). These weigh about 25 lbs. each.
- 24" round Cement Filled Bases are free-standing. These weigh about 90 lbs. each.
- In-Ground Gopher Sleeves are installed into poured concrete. Extended length Corner Poles are required.

NOTICE: Since the actual ground surface the Steel Base Plate or Gopher Sleeve will be installed on or in can vary greatly, please consult a contractor or other qualified professional who can best advise you on how to secure the Steel Base Plate or Gopher Sleeve to your ground surface.

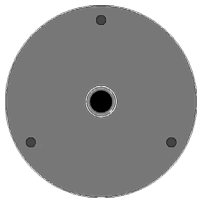

Steel Plate Base



Cement Filled Base



In-Ground
Gopher Sleeve

Tropitone®



MORE INFORMATION

For care and cleaning instructions, refer to the Tropitone Care, Maintenance, Safety & Warranty Information guide included with your furniture and available at www.tropitone.com – click on Product Care.

Additional care information, “How To” videos and assembly instructions for Tropitone Outdoor Furniture and Basta Sole shade products are also available at our website including:

- ✓ In-Ground Gopher Sleeve installation

If you have difficulty understanding any of the instructions and need assistance while assembling the Cabana / Pavilion, please call Tropitone’s Customer Service Center at 949-951-2010.

Tropitone Furniture Co., Inc.
5 Marconi, Irvine, CA 92618
949 951 2010 phone
www.tropitone.com

Part # R9T00008
Revised: 01-15-10
©2010 Tropitone Furniture Co., Inc.