

TROPITONE®

FIRE PIT INSTALLATION AND OPERATING INSTRUCTIONS

Models: 762342FP-18 & 762342FP-24

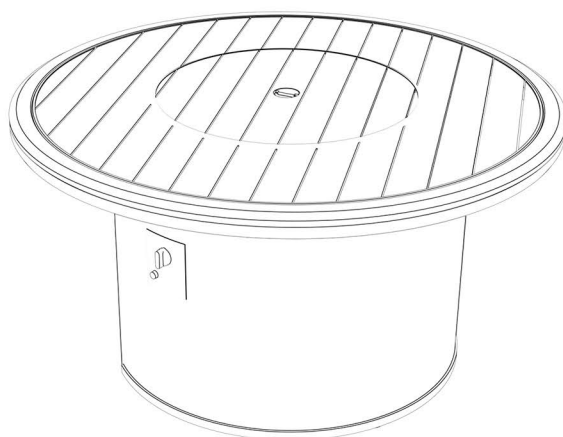

Warranty



THIS IS A RESIDENTIAL WARRANTY AND DOES NOT APPLY FOR COMMERCIAL USE



CAUTION: Read all the instructions before assembly. Failure to do so may result in faulty assembly and potential injury!

Assemble product on a soft, non-abrasive surface such as a carpet or cardboard to avoid damaging the item. Seek assistance to assemble bulky or heavy items. After final alignment, make sure all bolts are securely tightened with hex caps pressed in place.

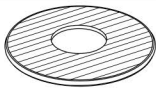
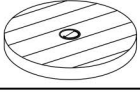
- **DO NOT TIGHTEN BOLTS** until full alignment is achieved

Parts List

| Item | PartName | Partpicture | Qty |
|------|----------|--|-----|
| A | Top |  | 1 |
| B | Lid |  | 1 |
| C | Base |  | 1 |

| Item | PartName | Partpicture | Qty |
|------|---------------|---|-----|
| D | Bolt M8x20 |  | 4 |
| E | Metal Washer |  | 4 |
| F | Wrench |  | 1 |

Assembly steps

Note: Do not fully tighten bolts until assembly is completed and alignment is correct.

Step 1:

Take fire pit top (A) and Base (C) from carton. Using wrench (F), attach table top (A) to base (C) with M8x20 bolt (D) and metal washer (E). Insert all four bolts loosely, then tighten one at a time.

See Figure 1.

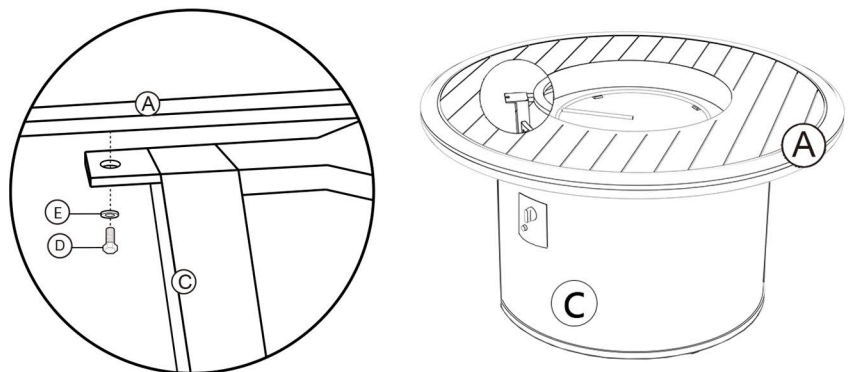

Figure 1

Step 2:

Install Fire Media (Sold separately)

See Figure 2.

Now your table is ready to use !

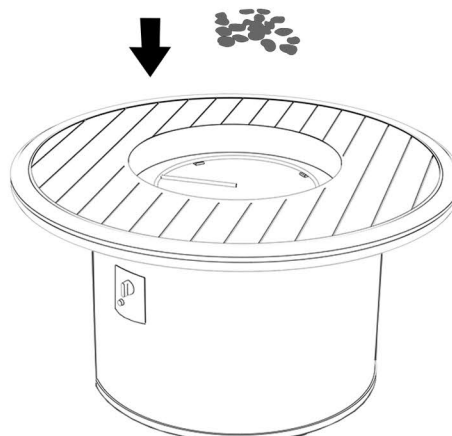

Figure 2

LAVA ROCK & GLASS MEDIA INSTALLATION GUIDELINES

Due to high temperatures, the Fire Pit must be located out of traffic areas and away from combustibles

#1



#2



#3



LAVA ROCK & GLASS MEDIA PLACEMENT

CAUTION— Cuts may occur from the sharp edges on glass. Use safety gloves during the placement of glass. Pour the bag of lava rocks or glass media into the Outdoor Fire Pit so that the burner is completely covered. (See figures #1 #2 #3). These instructions apply to round burners and rectangular burners.

Top View

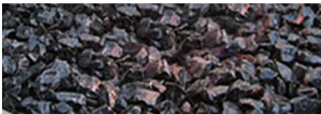

Figure 1



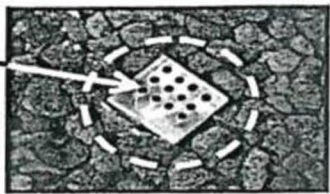

Figure 2



Figure 3

CAUTION: BURN HAZARD. LAVA ROCKS AND GLASS MEDIA REMAIN HOT FOR SOME TIME AFTER USE.

YOU MUST MAINTAIN THE LAYOUT AS SHOWN TO ENSURE PROPER OPERATION OF YOUR FIRE PIT. IF YOU NEED TO REPOSITION ANY MATERIAL TO MAINTAIN THE PROPER LAYOUT, USE HEAT RESISTANT GLOVES OR ALLOW MATERIAL ADEQUATE TIME TO COOL.

| | |
|--|---|
| <p> <u>WARNING</u></p> | <p>Screen </p> |
| <p> This screen must be clear and free of obstructions at all times to insure proper operation.</p> | <p>DO NOT PLACE LAVA ROCKS ON THE SCREEN. KEEP SCREEN CLEAR.</p> |

INSTALLER: Leave this manual with the appliance.
CONSUMER: Retain this manual for future reference.



WARNING

Do not store or use gasoline, or other flammable vapors and liquids, in the vicinity of this or any other appliance.

An LP-cylinder (Liquefied Petroleum) not connected for use shall not be stored in the vicinity of this or any other appliance.



DANGER

FIRE OR EXPLOSION HAZARD

If you smell gas:

Shut off gas to the appliance.

Extinguish any open flame.

If odor continues, leave the area immediately.

After leaving the area, call your gas supplier or fire department.

Failure to follow these instructions could result in fire or explosion, which could cause property damage, personal injury, or death.



WARNING: For Outdoor Use Only.

Installation and service must be performed by a qualified installer, service agency, or the gas supplier.



DANGER



CARBON MONOXIDE HAZARD

This appliance can produce carbon monoxide which has no odor.

Using it in an enclosed space can kill you.

Never use this appliance in an enclosed space such as camper, tent, car, or home.



WARNING: If the information in this manual is not followed exactly, a fire or explosion may result causing property damage, personal injury, or loss of life.

INSTALLATION

Tropitone recommends that all gas products be installed by professionals that are licensed by the local authority having jurisdiction in gas piping.

MAINTENANCE

Tropitone recommends that all gas products installed in the USA and CANADA be serviced and maintained by professionals that are certified by the National Fireplace Institute (NFI) as NFI Gas Specialist or by the Wood Energy Technical Training (WETT).



Follow the instructions in this manual carefully to reduce the risk of personal injury, death or property loss.



WARNING

Improper installation, adjustment, alteration, service, or maintenance can cause severe injury or death and may result in property damage. Read these installation, operating and maintenance instructions thoroughly before installing or servicing this equipment.

Some information listed in this manual has headings which have been highlighted in order to assist you in identifying critical pieces of information. They can be identified as follows:



WARNING Contains information critical to the safe installation and operation of the unit.



DANGER Contains information critical to the safety of you, your personal property and others around this product.



IMPORTANT Contains information that will help you to have the most enjoyable experience with this unit and maintain serviceability.



WARNING It is the installer's responsibility to ensure this product has been installed in accordance with the local codes applicable and that the end user has been educated on the safe and proper operation of the unit.



WARNING Tropitone recommends that all gas products installed in the USA and CANADA be serviced and maintained by professionals that are certified by the National Fireplace Institute (NFI) as NFI Gas Specialist or by the Wood Energy Technical Training (WETT).



DANGER This product is not intended to be used as a starter for wood or any other combustible material.



WARNING It is the installer's responsibility to ensure this product has been installed in accordance with all the local codes applicable. In the absence of local codes, please follow:

- For Fixed Piping Systems: The National Fuel Gas Code, ANSI Z223.1/NFPA 54 or the International Fuel Gas Code.
- For Electrical: The National Electrical Code, ANSI/NFPA 70.



WARNING Use only the gas or fuel type specified for this unit. See the label near the controls. Verify the gas or fuel is correct and the proper pressure available. NEVER use an alternative fuel, including bio-fuel, ethanol, or any other fuel type with this unit.

The proper pressure and gas type must be checked prior to installation. A 1/8" NPT test port is provided at the burner assembly connection beneath the burner tray.

- LP Gas:
- Supply Pressure: Minimum 8.0" WC (water column), Maximum 15.0" WC
- Outlet Pressure : Minimum 10.0" WC, Maximum 12.0" WC



DANGER All Fire Pits are designed and intended for outdoor use only. Never install or operate indoors. Burning gas (both Natural and LP) produces fumes which can be dangerous if inhaled. Always insure there is proper ventilation when using any fire products.



DANGER All Fire Pits are designed and intended for outdoor use only. Never install or operate indoors. Burning gas (both Natural and LP) produces very high temperatures. Always insure all combustible materials are kept far enough away to prevent accidental ignition.



IMPORTANT When selecting a location for this product, insure that there is at least 48” clearance to access the controls and the gas tank on LP units. Any guard or other protective device removed for servicing must be replaced prior to operating the appliance.



WARNING Never leave this product on when unattended. Educate all persons, including children that may come in contact with this unit of the danger of high temperatures produced when operating, including surface temperatures. Clothing and other flammable materials should not be hung from the appliance, or placed on or near the appliance. Young children should be carefully supervised when they are in the area of the appliance.



IMPORTANT It is recommended that material such as granite, marble or other dense stone be kept away from heat and flame due to the risk of cracking. Tropitone will not be held responsible for materials damaged due to excessive heat.



DANGER Do not install this product under any type of covering, including overhangs, patio covers, umbrellas, cabanas, tree limbs or branches. The risk of fire, inhalation of fumes, and exposure to excessive heat increases greatly if this product is installed under any type of covering, which could result in personal injury, damage to property or death.



IMPORTANT

- It is important that the gas line feeding the fire pit if piped is a minimum of 3/4” or larger, based on the distance from the fuel source.
- Choose a location which has proper drainage.
- Choose a location with a minimum clearance of 48” from other structures.



WARNING It is the responsibility of the person installing this unit to test and verify that there are no gas leaks after all connections are made. NEVER test for gas leaks with a flame. Use only a gas leak detector or gas reactant.



WARNING Use only joint compound or tape that is approved for use with all types of gas. Apply to all male pipe fittings only. DO NOT use on FLARED fittings. Be sure all joints are tightened securely before lighting.



WARNING Installation and repair should be done by a qualified service person. The appliance should be inspected before use and at least annually by a qualified service person. More frequent cleaning may be required as necessary. It is imperative that control compartment, burners, and circulating air passageways of the appliance be kept clean.



DANGER When using glass media in a fire pit, use only approved fire glass or fire pebbles and insure that there is only enough to hide burner. Applying over 1/2” of any media over the burner may create back pressure which can result in gas leakage from the air mixer. This may result in a dangerous situation which can result in personal injury, damage to property or death.



DANGER Do not use this appliance if any part has been under water. Immediately call a qualified service technician to inspect the appliance and replace any part of the control system and any gas control which has been under water.



Vertical Propane Tank



Horizontal Propane Tank



WARNING: The LP Gas tank or cylinder used must comply with the following requirements. Use of other tanks or cylinders which do not meet these requirements may create an unsafe condition which could cause injury or death to you, or damage to your personal property, including the risk of fire or explosion.

The cylinder or tank used must be:

1. Constructed and marked in accordance with the U. S. Department of Transportation (D.O.T.) Specifications for LP-Gas Cylinders, or the Standard for Cylinders, Spheres and Tubes for Transportation of Dangerous Goods and Commission, CAN/CSA-B339 as applicable;
2. Provided with a Listed overfilling prevention device; and
3. Provided with a cylinder connection device compatible with the connection for the appliance.



IMPORTANT: The LP Gas tank must be secured in the fire pit.

For 762342FP-24 height Firepits, Pull open drawer and place the Base of the tank into the round ring and secure with the two VELCRO straps.

For 762342FP-18 base, side horizontal LP gas tank along middle support until the back mounting bracket of the tank hits the back of the slot. Line up the holes in the front mounting bracket and the post on the front brace, then place the tank down.



DANGER Do not use a vertical LP gas tank in place of a horizontal LP gas tank in fire pits that have model numbers that end in -18.

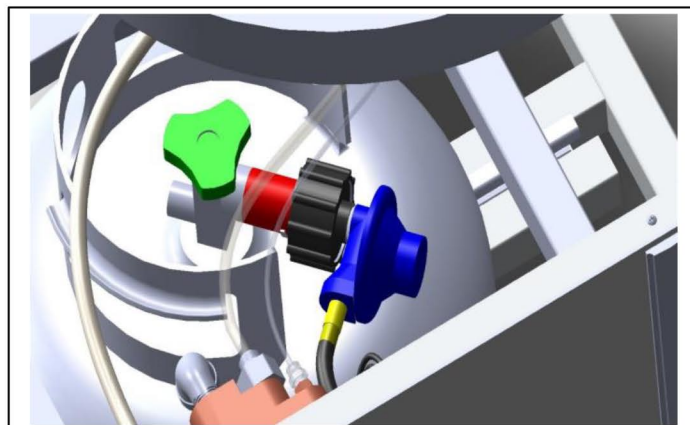

You can now connect your LP gas tank to the Fire Pit, using the standard propane gas hose with built in regulator (shown in blue). Hand tighten the propane tank gas connector (shown in black), to the tank valve (shown in red). **CAUTION:** Do NOT use tools to tighten this connection. Open the gas valve on the tank by turning the gas valve knob (shown in green) counter-clockwise (to the left) until fully open. **See diagram located at bottom of page 7.**

To remove the gas tank, first turn off the gas valve by turning the knob fully clockwise (right), then unscrew the gas connector counter-clockwise (left) and move the gas hose to a secure location to prevent accidental damage.



WARNING: Inspect the hose and tank connector before each use to insure there is no damage caused by rodents, weather or other conditions. NEVER use any Fire Pit which has any components, including the gas hose or gas tank connector damaged in any way. If you find any damage, turn off the valve on the gas tank and call a licensed repair technician to replace damaged components. Replace any damaged items with components that have the exact same ratings.



WARNING: Before you turn on your Fire Pit for the first time, you must test your connections to insure there are no leaks. Gas from leaking joints can pose a serious threat to your personal property, yourself and others near this Fire Pit. NEVER use a lit match, lighter or other sources of fire to check joints for leaks. Use a gas leak detection kit available from your local home improvement store and follow all directions supplied by the manufacturer.



WARNING: Inspect the burner assembly at least every six (6) months to insure there is no damage before use. Clean your burner, pilot and thermocouple at least every six months to insure proper operation.



The spark used to ignite your Fire Pit come from a 1.5 volt battery located in a Battery Case behind the ignition plate.

To replace the battery, remove the knob from the ignition plate (unscrew counter clockwise). Remove and replace battery positive terminal Facing out and replace the knob (Screw clockwise).

OPERATING THE UNIT-LIGHTING AND EXTINGUISHING

FOR YOUR SAFETY, READ BEFORE LIGHTING

WARNING: IF YOU DO NOT FOLLOW THESE INSTRUCTIONS EXACTLY. A FIRE OR EXPLOSION MAY RESULT, CAUSING PROPERTY DAMAGE, PERSONAL INJURY, OR LOSS OF LIFE

- A. BEFORE LIGHTING**, smell all around the unit area for gas. Be sure to smell next to the floor, because some gas is heavier than air and will settle on the floor.
- B. WHAT TO DO IF YOU SMELL GAS**
- 1. Shut off the gas to the appliance.**
 - 2. Extinguish any open flame.**
 - 3. If odor continues, immediately call your gas supplier or the fire department.**
- C. Use only your hand to push in or turn the gas control knob. Never use tools. If the knob will not push in or turn by hand, DO NOT try to repair it. Call a qualified professional service technician. Force or attempted repair may result in fire or explosion.**

ELECTRON LIGHTING INSTRUCTIONS

1. STOP! Read the safety information above.
2. Push and slowly turn the control knob to the HIGH position
3. Hold the ignitor to light the burner. release control knob after 45 seconds. See p1
4. Observe the flame height when lit. Flame should be UP to 13 inches high. See P2
5. If the burner does not light before the electron goes out, immediately turn the control knob to the OFF position.
6. Wait approximately five minutes to clear out any gas , and repeat steps 1-4 above.
7. If your burner fails to light again, turn the control knob to the OFF position and contact your dealer or gas supplier.
8. To extinguish your gas burner, turn the control knob to the OFF position. Be sure the control knob is turned fully off to avoid any gas leakage.

P1



P2



Pictorial representation of approximate flame

CONVERTING TO A DIFFERENT GAS TYPE

The oriface needed to convert this fire pit to natural gas has been included.
Please contact a local licensed plumber to perform this conversion.

Note: A sticker should be placed on the fire pit nothing conversion to Natural Gas.

OPERATION

Each installation site for any unit presents its own unique combustion environment. Specific factors such as weather, wind currents, yard debris, altitude, drafts, the size of the surrounding area, all have an influence on the proper operation of the unit. A normally operating unit will demonstrate the following characteristics:

a) A lively, realistic yellow flame,

b) Odor-free.

• If the flame is not clean (identifiable by excessive sooting on the decorative media), refer to the CLEANING AND MAINTENANCE section below.

A. Always shut off the gas to the unit while performing service work.

B. Allow the unit to cool before servicing.

C. The unit should be inspected regularly. Excessive debris can build up on this unit from leaves, dirt, or other debris. It is critical that all control components, burners, and the surrounding area be kept clean and free of all obstructions.

Keep the surrounding area at the base of the unit clean and free of obstructions at all times.

D. The burner assembly must be replaced prior to the unit being put into operation if it is evident that the burner is damaged. Contact your local dealer for replacement parts.

E. Periodically perform visual checks of the burner flames. The burner flames should be blue at the base with a combination of blue/yellow at the body and tips.

Contact a qualified service person for maintenance.

Keep entire area (around bottom) clear for proper venting

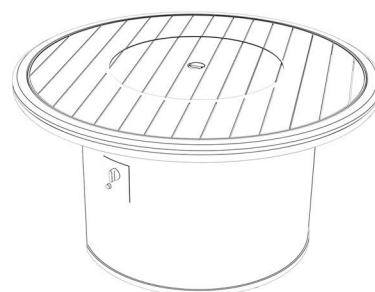

CLEANING & MAINTENANCE

CAUTION

HOT DURING OPERATION AND AFTER USE

Children must be supervised when in the vicinity of this appliance as serious injury may occur !

Children must be alerted to the hazard of high surface temperatures and should stay away to avoid burns or clothing ignition.

Tropitone Furniture Co., Inc.

5 Marconi
Irvine, Ca 92618
949-951-2010
www.tropitone.com

1401 Commerce Blvd.
Sarasota, Fl 34243

© Tropitone Furniture Co., Inc, 2023

